

**ANSWER KEY**

**WORK FROM HOME – DVET RO Nashik MDES Group**

**ANNUAL PATTERN (Second Year)**

QUESTIONS PAPER - Date – 12 July 2020

**Two Year Trades (ET/EM/IT) Group**

SUBJECT : ENGINEERING DRAWING

TIME - 3 Hrs.

MARKS – 50

**Q.1 Draw the symbols of following ( Any Ten )**

**Answers**

1) DIODE



2) NPN Transistor

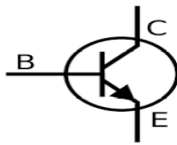

3) RESISTOR



4) LDR

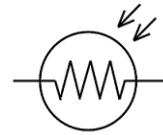

5) LED

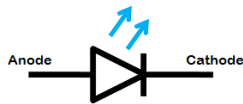

6) JOINT



7) Cell

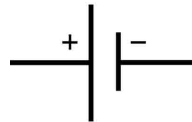

8) Two Way Switch

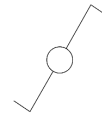

9) Coil

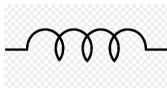

10) Loudspeaker

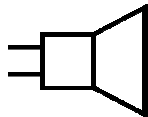

11) Direct Current



12) Fuse

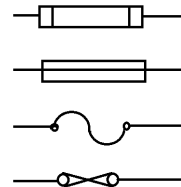

13) AND Gate

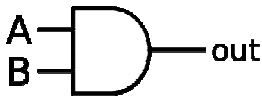

14) NAND Gate

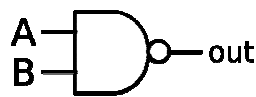

15) Condenser

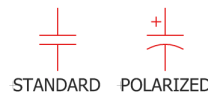

**Q.2 Draw Neat Sketch of Pipe Earthing.**

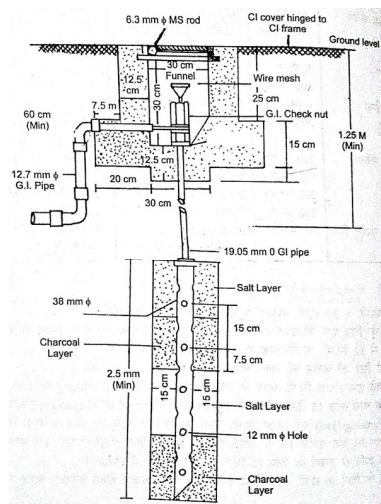
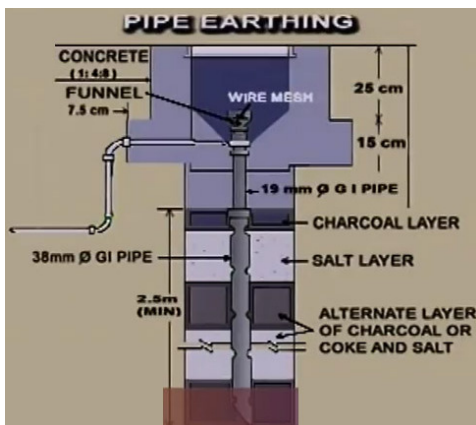

OR

### Block Diagram of AM Receiver

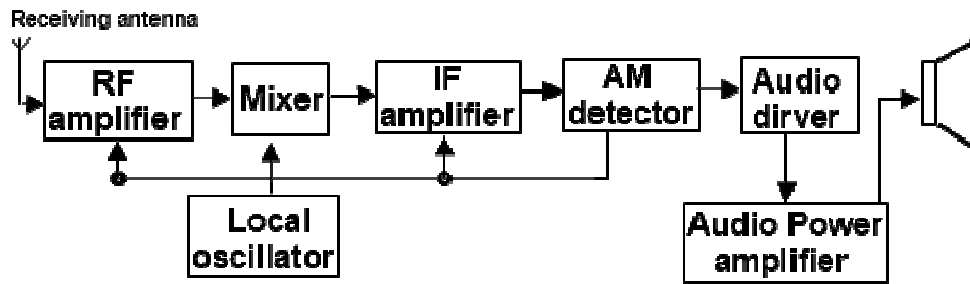

### Q.3 Draw Series Circuit & Parallel Circuit Diagram

Series Circuit

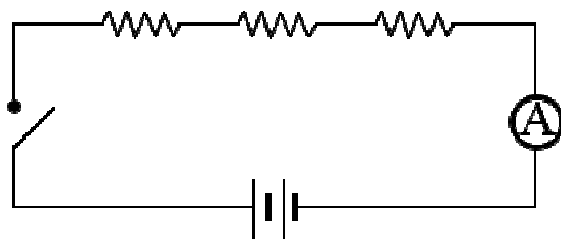

Parallel Circuit

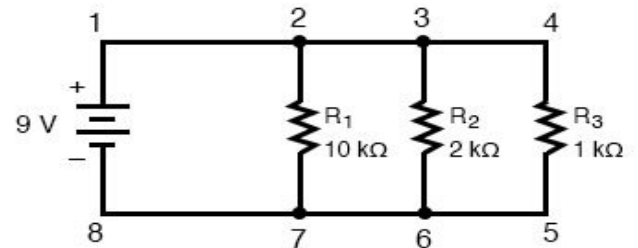

### OR Half Wave Rectifier

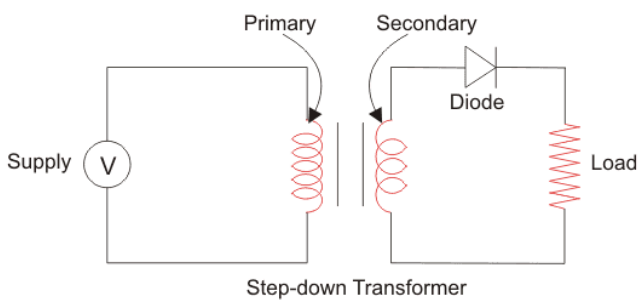

### Four Input EX-OR Gate

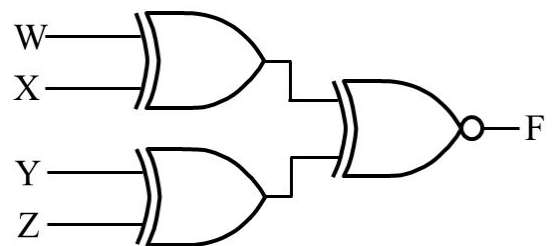

## Q.4 Draw Typical Motherboard Layout

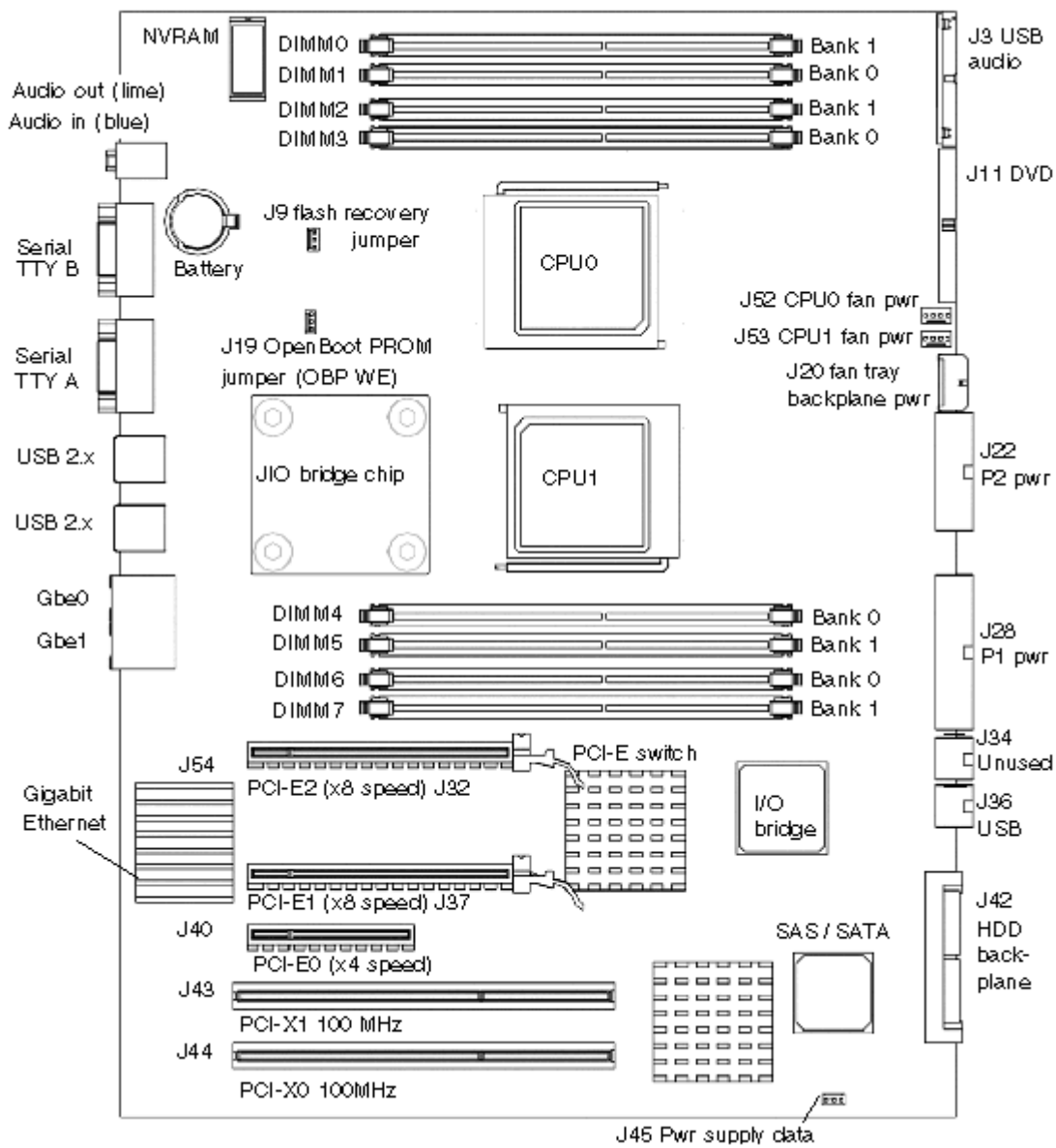

## OR Connection Diagram of Capacitor Start Capacitor Run Motor

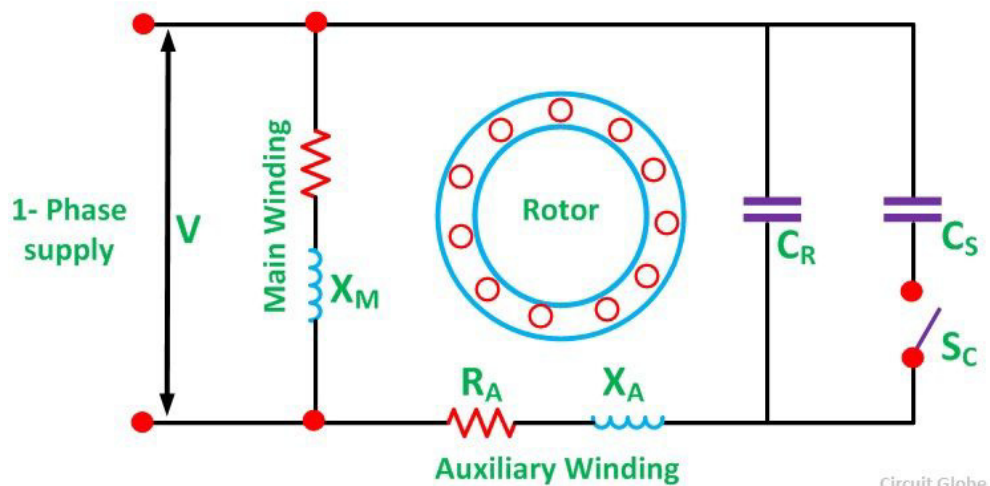

**Q.5 Draw Four point starter with connection of DC Shunt motor**

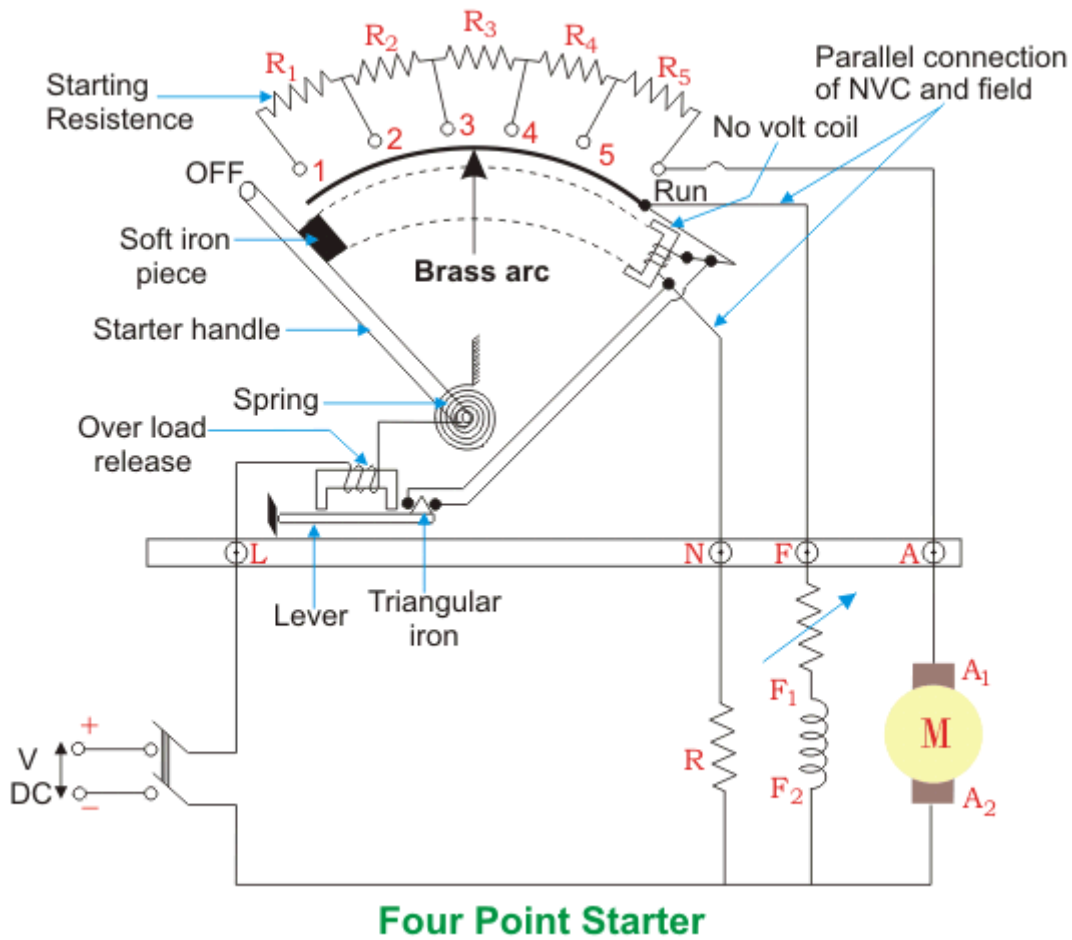

**OR Draw Block Diagram of Cellohne**

